

1T8238DA80 | CCTEVO DOWNLIGHT 214

Recessed LED Downlight in a trim version

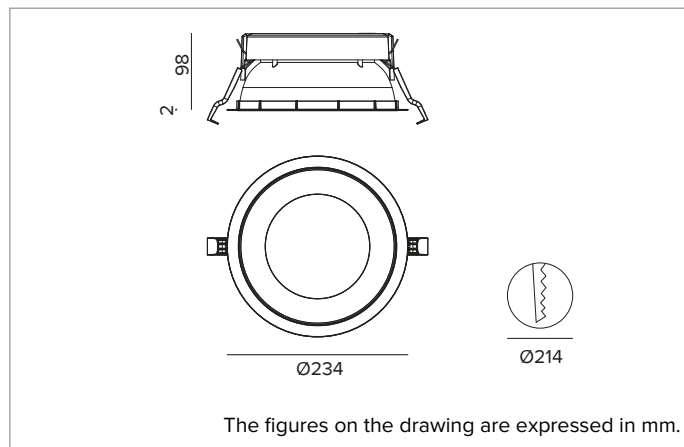

	3500K	H(m)	D(m)	E _{max} (lx)
	Ra80		88°	
Fixture Power	54W	1	1.92	3701
Source Flux	7623lm	2	3.85	925
Fixture Flux	6389lm	3	5.77	411
Efficacy	118lm/W	4	7.69	231
TS1566	I _{max} =485cd/klm	I _{max}	3701cd	5
			9.61	148



SOURCE

High efficiency Chip on Board LED Ra80.

Energy efficiency class: D

Nominal power: 49W

Nominal flux: 7623lm

Colour rendering index: 80

Rf: 83

Rg: 95

CCT nominal: 3500K

Lifetime (L80/B10): >50000h tq +25°C

ILLUMINOTECHNICAL CHARACTERISTICS

VWFL Optic for wide coverage and excellent uniformity of luminance. Optic with high luminous efficiency composed of a thermoplastic reflector with reflective metallisation and a protective anti-scratch coating, a holographic acrylic diffuser screen and a highly reflective white thermoplastic internal recuperator. IP54 protection for the visible parts of the installed fixture.

Optic: REFLECTOR

Beam angles: VWFL

Optical efficiency: 84%

Fixture flux: 6389lm

Luminous efficacy: 118lm/W

Photobiological safety: Compliant with RG1 low risk group

MECHANICAL CHARACTERISTICS

Die-cast black painted anodised aluminium heat sink. Reflective metallised thermoplastic material reflector with high luminous efficiency and visual comfort. Silicone sealing kit for water and dust protection. Trim version with an integrated white ring.

Colour and finish: Plaster white

Weight: 1.25Kg

Version: TRIM

Degree of protection: IP20 for recessed part

Degree of protection: IP54 for exposed part

ELECTRICAL CHARACTERISTICS

Integrated DALI driver. Luminaire compliant with EN 60598-2-22 for power supply from a centralised emergency system CPSS (Central Power Supply System), not incorporated in the luminaire - high risk areas excluded. The default power and flux are 100% in AC and 15% in DC.

Fixture Power: 54W

Power supply: 220-240Vac 50/60Hz

Insulation Class: CLASS 2 WITH FUNCTIONAL EARTH

Type of driver / Control: DALI - PUSH

Driver included: YES

Class F: YES

SAFE FLICKER: PstLM=<1 and SVM=<0.4 (IEC TR 61547-1 and IEC TR 63158), to ensure a more comfortable and safe light

Ambient temperature: 0°C / +25°C

INSTALLATION

Quick tool-free mounting system for false ceiling installation from 0.5 to 30mm.

NOTES

Casambi control system available using a dedicated accessory. 110-277Vac version available on request. Commissioning of the control system via free APP; the intervention of a specialist technician can be quoted on request.

WARRANTY

5 years.

WARNING

Luminaire designed for disposal/recycling at end-of-life. Replaceable (LED only) light source by a professional. Replaceable control gear by a professional.

Due to the technological evolution of the electronic components, the data provided may be updated, and as such, confirmation must be requested during the order process.

Luminous flux and power supply have +/-10% tolerances with respect to the indicated value. tq +25°C (CIE 121).

We reserve the right to make technical changes.

Targetti Sankey S.r.l.
Via Pratese, 164
50145 Firenze - Italy
Tel: +39 055 37911
targetti.com
targetti@targetti.com

CCIAA Firenze
Share Capital:
€ 500.000,00
VAT N. (IT):
01537660480
R.E.A.: FI-275656

TARGETTI

1T8238DA80 | CCTEVO DOWNLIGHT 214

Recessed LED Downlight in a trim version

Accessories

Mounting System



L mm	Code
2500	1T9606

Anti-fall safety cable to secure the body of the appliance to the building structure.

Emergency Kit



Code
A059

Emergency kit composed of an inverter a LiFePO4 battery and a LED Green indicator. Allows permanent EP emergency use of the fixture it is connected to. The 1h or 3h autonomy can be selected by configuring the fixture. The batteries take 12h to completely recharge. LED Green indicator wired to the inverter through single-core cables L= 800mm. Emergency kit for fixtures that comply with EN 60598-2-22 standard, high risk areas excluded. Battery size 160x54x30 mm. Inverter size 165x40x25 mm.

Control systems



Code
1T5349

IP20 wireless control unit with DALI interface. It generates a local DALI2 bus, enabling a direct connection to a DALI interface LED driver. The module can only be used in a closed system and cannot be connected to an existing DALI network. The module is wireless controlled using a Casambi app for smartphones and tablets using Bluetooth 5.0 technology. The devices automatically create an adaptive, robust, and reliable wireless mesh network, allowing for the easy and efficient management of a high number of fixtures. The control unit is preset to the DALI 1CH profile, meaning the device can control a single DALI driver with broadcast commands. In addition to the DALI broadcast, other operating modes are available, such as:

- Button (normally open)
- Control unit 0/1-10V
- Control unit DALI Tunable White DT8
- Presence sensor



Code
2T0131

IP20 Extender for wireless control of LED driver with dimming DALI (or 1-10V) interface based on Casambi technology. It has a DALI2 output with the capacity to control up to 40 lighting fixtures. With the addition of a further external BUS DALI power supply it is possible to control up to 64 fixtures. IP20 Extender is preset to the DALI broadcast profile, meaning all the luminaires connected to it are dimmable at the same level. In addition to the DALI broadcast other operating modes are available, such as:

- EXTENDER DALI 8CH
- EXTENDER DALI Tunable White
- EXTENDER 0/1-10V
- EXTENDER DALI 4CH
- EXTENDER DALI DT8 Tunable White

Due to the technological evolution of the electronic components, the data provided may be updated, and as such, confirmation must be requested during the order process. Luminous flux and power supply have +/-10% tolerances with respect to the indicated value. tq +25°C (CIE 121).

We reserve the right to make technical changes.

Targetti Sankey S.r.l.
Via Pratese, 164
50145 Firenze - Italy
Tel: +39 055 37911
targetti.com
targetti@targetti.com

CCIAA Firenze
Share Capital:
€ 500.000,00
VAT N. (IT):
01537660480
R.E.A: FI-275656

